

**MUSTANG SURVIVAL**



# OWNER'S MANUAL



**MD2014 INFLATABLE PFD**  
Manual Inflation Model

**USCG APPROVALS:**  
RECREATIONAL: TYPE III  
UNINSPECTED COMMERCIAL  
VESSELS: TYPE V

**MD2016 INFLATABLE PFD**  
Manual with Automatic  
Backup Inflation Model

**USCG APPROVALS:**  
RECREATIONAL: TYPE III  
UNINSPECTED COMMERCIAL  
VESSELS: TYPE V

**WE SAVE LIVES FOR A LIVING**

**DO NOT REMOVE PRIOR TO SALE**

## TABLE OF CONTENTS

APPROVAL CONDITIONS AND CARRIAGE REQUIREMENTS.....	1
NOTE TO UNINSPECTED COMMERCIAL VESSEL OPERATORS .....	1
WHY ARE PFDS REQUIRED SAFETY EQUIPMENT? .....	2
WHAT IS AN INFLATABLE PFD?.....	2
INSTRUCTIONS FOR USE .....	2
Uninspected Commercial Vessel Use.....	2
Component Inspection Instructions.....	3
Readiness Checklist .....	3
Sizing and Fit.....	4
DONNING INSTRUCTIONS .....	4
INFLATING YOUR INFLATABLE PFD .....	5
SPECIAL CONSIDERATIONS FOR AUTOMATIC DEVICES (MD2016) .....	6
DEFLATING THE INFLATABLE PFD .....	7
USAGE BELOW FREEZING .....	8
RE-ARMING YOUR PFD (MD2014) .....	8
RE-ARMING YOUR PFD (MD2016) .....	10
REPACKING .....	13
IS YOUR PFD IN GOOD AND SERVICEABLE CONDITION? .....	13

CARE AND MAINTENANCE INSTRUCTIONS .....	14
CLEANING AND STORING OF YOUR INFLATABLE PFD (MD2014).....	16
CLEANING AND STORING OF YOUR INFLATABLE PFD (MD2016).....	16
HOW AND WHY TO TEST YOUR PFD.....	16
MODEL MD2016 .....	17
HOW DO YOU TEST YOUR PFD USING THE AUTOMATIC INFLATOR? (MD2016).....	17
HOW DO YOU TEST YOUR PFD USING THE MANUAL INFLATOR?....	18
HOW DO YOU TEST YOUR PFD USING THE ORAL INFLATOR?.....	19
WEAR YOUR PFD.....	19
HYPOTHERMIA .....	20
EACH OF THESE DEVICES IS INTENDED TO HELP YOU SAVE YOUR OWN LIFE .....	21
INFLATABLE PFD SAFETY ACCESSORIES .....	21
ADDITIONAL INFORMATION.....	22
DO NOT ATTACH PFD'S TO YOUR BOAT.....	22
AIRLINE OPERATOR POLICY ON CARRIAGE OF INFLATABLE PFDs AND CO <sub>2</sub> CARTRIDGES .....	22

## APPROVAL CONDITIONS AND CARRIAGE REQUIREMENTS

**Recreational** - This Inflatable PFD is approved by the U.S. Coast Guard (USCG) for use as a Type III Personal Flotation Device (PFD). It is not approved for water skiing or other high impact, high-speed activities.

This Inflatable PFD was designed to be more comfortable and less restrictive to wear than inherently buoyant PFDs. When worn, used, and serviced according to this owner's manual, this Inflatable PFD can greatly increase your chances of survival in the water. Not recommended for non-swimmers or weak swimmers. Users of inflatable PFDs must be at least 16 years old.

**Commercial** - Models MD2014 and MD2016 are U.S. Coast Guard approved Type V inflatable PFDs, approved ONLY WHEN WORN for use on uninspected commercial vessels less than 40 feet in length not carrying passengers for hire as a substitute for a Type III PFD when used in accordance with this owner's manual.

Conditions for Type V Approval in commercial applications:

1. The Inflatable PFD must be worn before getting underway and whenever above deck and not within an enclosed space to meet the carriage requirement.
2. The operator of an uninspected commercial vessel is responsible for servicing and maintaining the Inflatable PFD in good serviceable condition in accordance with this owner's manual. See Care and Maintenance Instructions for servicing information.
3. The operator of an uninspected commercial vessel is responsible for providing each person onboard with the safety information required for use of the Inflatable PFD. See page 1 for information.

## NOTE TO UNINSPECTED COMMERCIAL VESSEL OPERATORS

The operator of the vessel is required to provide the following user information to each person on board.

Inflatable PFDs will not provide any buoyancy without being inflated. Follow these instructions to be sure your PFD is armed and donned correctly, and that you understand how to inflate the device.

Basic visual inspection for readiness (see "Readiness Checklist" on page 3).

Inflation system status check (see "Care and Maintenance Instructions" on page 14).

Donning (see "Donning Instructions" on page 4).

Inflation (see "Inflating Your Inflatable PFD" on page 5).

## **WHY ARE PFDs REQUIRED SAFETY EQUIPMENT?**

Drownings are the leading cause of fatalities involving recreational boating. A PFD provides flotation to help keep your head above water, help you to stay face up in the water, and increase your chances for survival and rescue. Most adults only need an extra 7 to 12 lb (3.2 to 5.5 kg) of flotation to keep their heads above water. The proper size PFD will properly support the weight of the wearer.

Since this Inflatable PFD does not have inherent buoyancy, it provides flotation only when inflated. Familiarize yourself with the use of this Inflatable PFD so you know what to do in an emergency.

## **WHAT IS AN INFLATABLE PFD?**

While traditional PFDs are inherently buoyant, inflatable PFDs rely entirely on inflation for buoyancy. Uninflated, the Inflatable PFD is a comfortable slim collar that can be inflated at any time with a CO<sub>2</sub> gas cylinder. The Inflatable PFD is designed to offer maximum mobility with minimum bulk. The Inflatable PFD (MD2014) can be inflated either manually by jerking a pull-tab, or orally (by mouth). The Inflatable PFD (MD2016) can be inflated either automatically during water immersion, manually by jerking a pull-tab, or orally by mouth. It is recommended that you familiarize yourself with the procedures outlined in INSTRUCTIONS FOR USE .

## **INSTRUCTIONS FOR USE**

This manual supplies instructional, maintenance and safety information for models MD2014 and MD2016. Model numbers are listed on the underside label.

Congratulations on your Inflatable PFD purchase!

### **UNINSPECTED COMMERCIAL VESSEL USE**

This Inflatable PFD is not approved for "hot work" and care must be

taken to avoid damage from abrasion and sharp objects.

## COMPONENT INSPECTION INSTRUCTIONS

- 1) Examine the service indicator through the window panel (Fig. 1). Ensure the service indicator is green. If the service indicator is red, the mechanism has been fired or is incorrectly fitted (see "Re-arming Your PFD (MD2014)" on page 8 or see "Re-arming Your PFD (MD2016)" on page 10).

---

**NOTE: The service indicator must be green before proceeding.**

---

- 2) Undo the Velcro™ strips along both sides of the PFD.

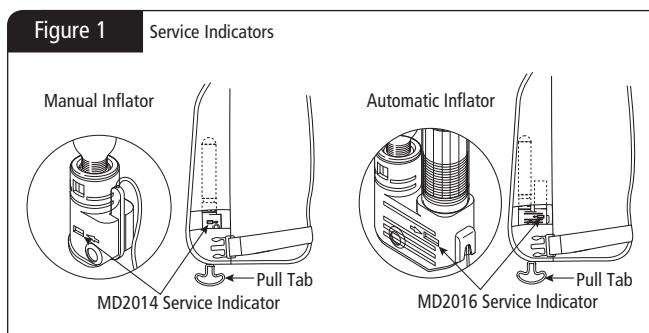

- 3) Ensure the oral-inflation dust cap is in the stowed position (Fig. 6).
- 4) Ensure the service indicator is green and the pull-tab lanyard is hanging on the outside (Fig. 1); secure the Velcro™ strips on both sides of the Inflatable PFD.
- 5) For the MD2016 only - Ensure the bobbin is valid. The PFD, or bobbin, must have been purchased within the last three (3) years. If the purchase date is unknown, check the date printed on the bobbin and replace if older than three (3) years (see Re-arming Your PFD (MD2016) on page 10).

## READINESS CHECKLIST

Check your Inflatable PFD and ensure all of the checkpoints listed below are true before use.

- Service indicator is green (Fig. 1).
- No rips, tears or holes; all seams are securely sewn; and the fabric,

straps and hardware are still strong.

- All Velcro™ and waist belt are securely fastened.
- Inflatable PFD is not twisted.
- Oral-inflation dust cap is in the stowed position (Fig. 6).
- For the MD2016 only - Ensure the bobbin is valid. The PFD, or bobbin, must have been purchased within the last three (3) years. If the purchase date is unknown, check the date printed on the bobbin and replace if older than three (3) years (see Re-arming Your PFD (MD2016) on page 10).

Your Inflatable PFD is ready for use if all applicable boxes are checked.

---

**NOTE: Contact your Mustang Dealer if you have any concerns about the readiness of your Inflatable PFD.**

---

## SIZING AND FIT

This PFD provides a minimum of 22.5 lbs of buoyancy when inflated and is designed for wearers over 16 years of age, with a chest range of 30-52 inches (76-132 cm) weighing over 80 pounds (36 kg).

## DONNING INSTRUCTIONS

It is important that the Inflatable PFD is properly adjusted to fit the person wearing it. An incorrect fit or improper fastening of attachments could impede its effectiveness.

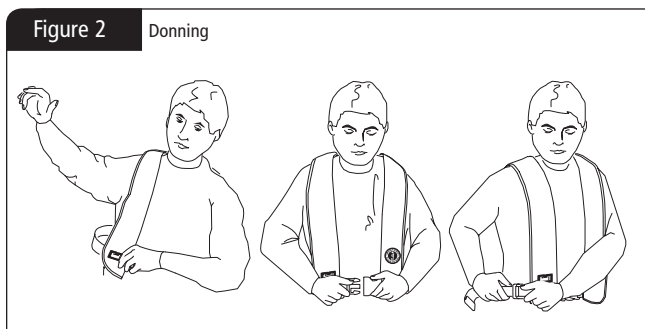

- 1) All belts and straps are already threaded correctly and only need to be adjusted for fit. The belt should fit below your rib cage adjusted to a tight personal fit.

- Put the Inflatable PFD on just like a jacket (Fig. 2) and fasten the front buckle. Adjust the waist belt using the side buckle on the belt and secure the belt's loose end in the belt loop.

---

**WARNING: Do not wear Inflatable PFDs under clothing as the inflation could be restricted or you could be injured.**

---

## INFLATING YOUR INFLATABLE PFD

It is recommended that the following procedures be followed to inflate your Inflatable PFD:

### 1) Manual Inflation

Activate the inflation system by jerking firmly downward on the pull-tab (Fig. 3). The Inflatable PFD should fully inflate within 5 seconds.

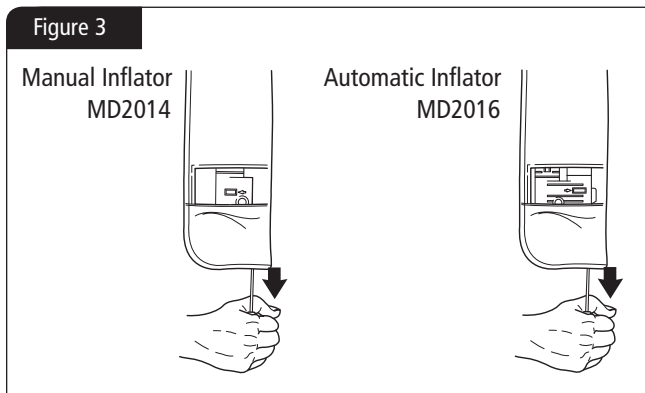

### 2) Automatic Backup Inflation (MD2016)

Inflation will occur automatically within 10 seconds after the inflator is immersed in water. The water-sensing bobbin will disintegrate, triggering a spring-loaded plunger, which punctures the CO<sub>2</sub> cylinder (Figs. 10 and 11) to inflate the Inflatable PFD.

### Information

When inflated, the carbon dioxide (CO<sub>2</sub> gas) used to inflate the PFD will slowly escape through the fabric over time. A slight reduction of pressure will be observed after several hours of inflation. Topping up by oral inflation may be required in the event of very prolonged immersion.



---

**IMPORTANT: See Special Considerations for Automatic Devices**

---

Figure 4



### 3) Oral Inflation

Properly armed and inspected Inflatable PFDs will inflate when manually or automatically activated. However, you can fully inflate the Inflatable PFD by mouth (Fig. 4) should inflation not occur, or if you are in a non-emergency situation. To orally inflate the Inflatable PFD, first locate the oral inflation tube by opening the wearer's left front panel of the Inflatable

PFD. Remove the dust cap from the end of the oral tube and blow into the tube until the Inflatable PFD is fully inflated.

Place the oral inflator dust cap back in the stowed position (Fig. 6).

---

**WARNING: Avoid double inflation (CO<sub>2</sub> cylinder inflation after full oral inflation) as it could damage the PFD.**

---

## SPECIAL CONSIDERATIONS FOR AUTOMATIC DEVICES (MD2016)

The Inflatable PFD might not be armed when needed, either knowingly or unknowingly. Premature automatic inflation causes several risks that you must address to avoid drowning. Much less common but also important are:

---

**WARNING: Avoid double inflation (CO<sub>2</sub> cylinder inflation after full oral inflation) as it could damage the PFD.**

---

- 1) Inflation when stored in a tight space could damage the PFD, and
- 2) The PFD could inflate when you are in an awkward place or position.

Premature inflation may occur in certain conditions, including when the device is subjected to: heavy splashing, high humidity, heavy fog, and heavy rain.

Care and attention should be taken to ensure that when the device is used in these types of conditions, auto-inflation does not occur prematurely.

If this PFD should inflate prematurely, a re-arm kit (MA2014) is required to re-arm the device.

---

**IMPORTANT: The Inflatable PFD should be re-armed according to the instructions (see "Re-arming Your PFD (MD2016)" on page 10).**

---

## DEFLATING THE INFLATABLE PFD

- 1) To deflate the Inflatable PFD, reverse the oral-inflation tube dust cap and insert it into the valve. The dust cap will not lock in the deflate position so it is necessary to hold it in place (Fig. 5).
- 2) Gently squeeze the Inflatable PFD until all air or gas has been expelled. To avoid damage, do not wring or twist the Inflatable PFD. Put the inflation tube dust cap back in its stowed position on the oral inflation tube (Fig. 6).
- 3) Examine the service indicator (Fig. 1). If the service indicator is red, the mechanism has been fired or is incorrectly fitted and the inflator requires service (see Re-arming your PFD (for your model)).

---

**NOTE: The service indicator must be green before proceeding.**

---

- 4) Your device is ready to be repacked (see "Repacking" on page 13).

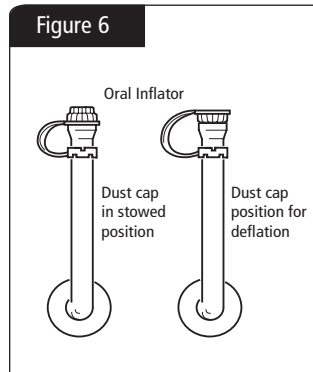
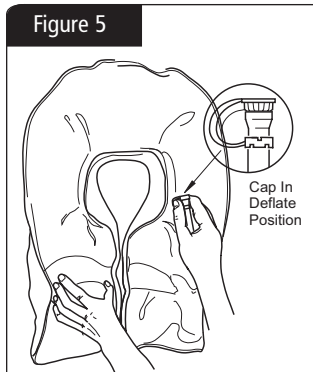

## USAGE BELOW FREEZING

When the temperature is below freezing, the Inflatable PFD should be worn partially inflated because a fully discharged cylinder may not quickly or adequately inflate your Inflatable PFD. Under these conditions use the oral inflator to adequately top-up the PFD, after CO<sub>2</sub> inflation.

**WARNING: CO<sub>2</sub> inflation could over-pressurize and damage your Inflatable PFD if already fully inflated.**

## RE-ARMING YOUR PFD (MD2014)

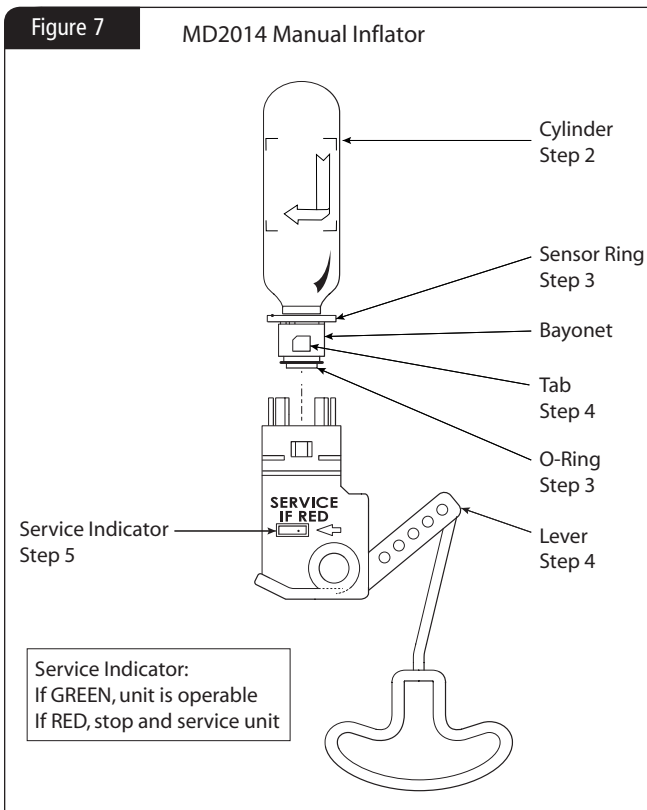

---

**NOTE: A re-arm kit (MA2014) is required for this procedure.**

---

**IMPORTANT: Follow instructions in the exact sequence below.**

---

- 1) Open inflator cover flap so that manual inflator is exposed (Fig. 7).
- 2) Remove the cylinder/bayonet assembly by rotating counterclockwise and then pull out. **Discard the used cylinder/bayonet assembly.**
- 3) Check the new cylinder/bayonet assembly to ensure the o-ring is in place and the sensor ring is attached (Fig. 10). Ensure that the CO<sub>2</sub> cylinder has not been pierced (Fig. 10).

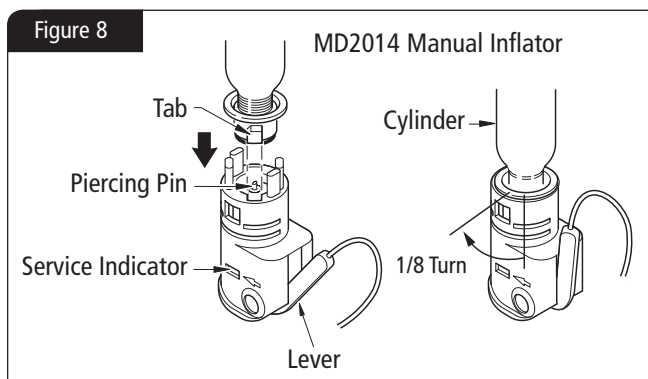

- 4) Raise, and hold, the lever into the inflator housing. Install a new cylinder/bayonet assembly by engaging bayonet tabs in housing, pushing in then turning clockwise 1/8 turn to a full stop (Fig. 8).
- 5) Examine the service indicator (Fig. 8) and ensure it is GREEN. If the service indicator is red, the mechanism has been fired or is incorrectly fitted and the inflator requires service (see "Re-arming Your PFD (MD2014)" on page 8).

---

**NOTE: The service indicator must be green before proceeding.**

---

- 6) Refold the Inflatable PFD in accordance with the Repacking section (see "Repacking" on page 13)

**YOUR INFLATABLE PFD (MD2014) IS NOW READY FOR MANUAL USE**

## RE-ARMING YOUR PFD (MD2016)

Figure 9

MD2016 Automatic Inflator

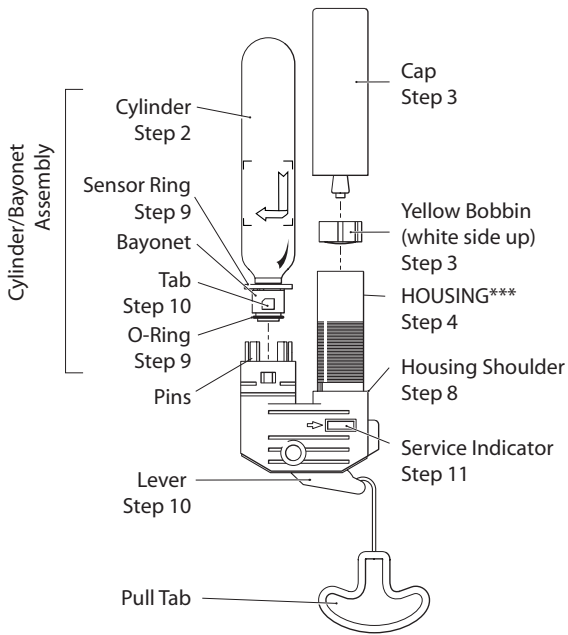

Service Indicator:  
If GREEN, unit is operable  
If RED, stop and service unit

**NOTE:** A re-arm kit (MA2014) with a valid bobbin install-by-date (check re-arm kit packaging) is required for this procedure.

**IMPORTANT:** Follow instructions in the EXACT sequence below.

- 1) Open inflator cover flap so that the manual/automatic inflator is exposed (Fig. 9).
- 2) Remove the cylinder/bayonet assembly by rotating counter-clockwise and then pull out. **Discard the used cylinder/bayonet assembly.**
- 3) Remove cap by turning counter-clockwise. (Fig. 9).
- 4) Remove bobbin from cap or housing unit. **Discard bobbin.**

---

**NOTE: The yellow bobbin may remain in the housing or in the cap assembly when you remove the cap. The bobbin must be removed prior to re-arming.**

---

- 5) Check the housing to be sure it is clear and dry. If necessary, rinse the inflator with fresh water to remove dirt and salt. Let dry before going to step 6.
- 6) Inspect the bobbin. If the bobbin has been fired or damaged, replace it! Ensure the new bobbin is valid. It must have been purchased within the last three (3) years. If the bobbin purchase date is unknown, check the manufacturing date printed on the bobbin and replace if older than three (3) years.
- 7) **IMPORTANT!** Bobbin (yellow) must be installed into the HOUSING (\*\*\*)Figure 9), white side up, aligning the slots on the bobbin with the ridges inside the threaded housing. The bobbin will slide in easily if installed correctly.
- 8) Install cap by screwing clockwise until it meets the housing shoulder.
- 9) Check the new cylinder/bayonet assembly to ensure the o-ring is in place and the sensor ring is attached (Fig. 9). Ensure that the CO<sub>2</sub> cylinder has not been pierced (Fig. 10).

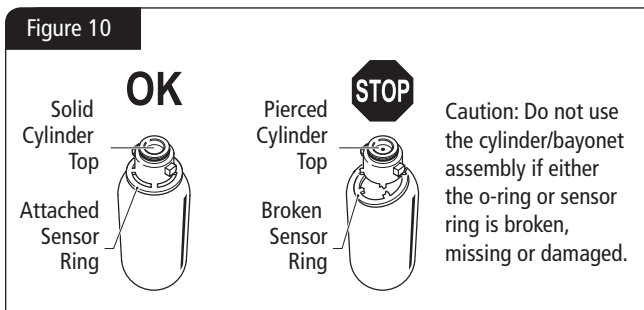

**IMPORTANT: You will damage the sensor ring if bobbin and cap are not installed first.**

- 10) Push, and hold, the lever into the inflator housing. The pull-cord should be situated in the groove (Fig. 11). Install a new cylinder/bayonet assembly by engaging bayonet tabs in housing, pushing in then turning clockwise 1/8 turn to a full stop (Fig. 11).
- 11) Examine the service indicator (Fig. 9) and ensure it is GREEN. If the service indicator is red, the mechanism has been fired or is incorrectly fitted and the inflator requires service.

**NOTE: The service indicator must be green before proceeding.**

- 12) Refold Inflatable PFD in accordance with the Repacking section (see "Repacking" on page 13).

YOUR INFLATABLE PFD (MD2016) IS NOW READY FOR MANUAL USE WITH AUTOMATIC BACKUP

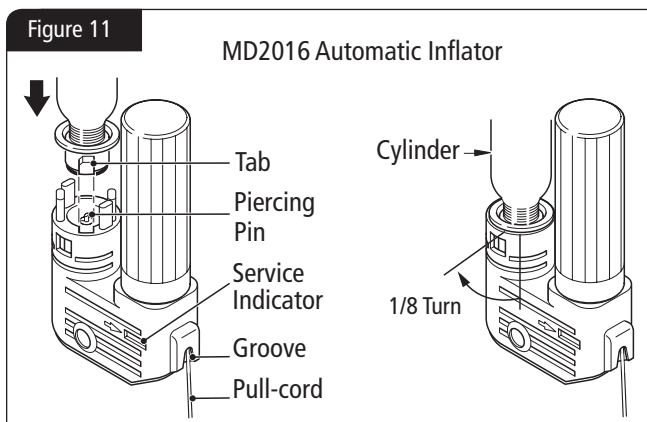

## REPACKING

Gently squeeze the Inflatable PFD with the oral tube dust cap in the deflate position (Fig. 6, page 7) until all air or gas has been expelled (Fig. 5, page 7). Do not wring or twist the Inflatable PFD. Put the oral tube dust cap back in its stowed position on the oral inflation tube (Fig. 6, page 7).

---

**NOTE: Before following the repacking sequence, be sure to properly re-arm your Inflatable PFD.**

---

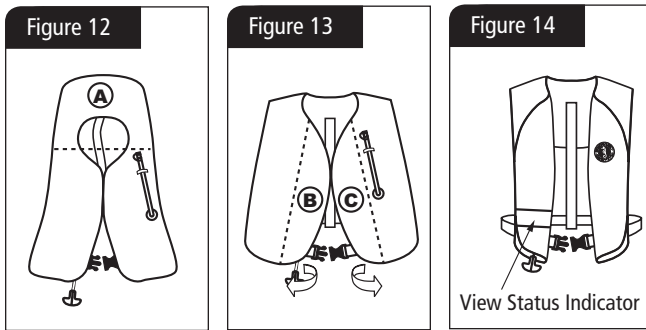

1. Fold lapel (A) back along the dotted line (Fig. 12).
2. Fold sides (B) and (C) outward along dotted lines. Secure with Velcro™.
3. Make sure inflator status indicator is viewable through window.
4. Make sure the inflator pull-tab is on the outside of the folded PFD. Fig. 14 depicts a correctly folded PFD.

---

**NOTE: Ensure that all Velcro™ strips are fastened.**

---

## IS YOUR PFD IN GOOD AND SERVICEABLE CONDITION?

Check your Inflatable PFD between outings to be sure that it is properly armed; that it is free of rips, tears or holes; that all seams are securely sewn; and that the fabric, straps and hardware are still strong (see "Readiness Checklist" on page 3). Inspect the inflatable portion of the Inflatable PFD in accordance with the CARE AND MAINTENANCE INSTRUCTIONS.



## CARE AND MAINTENANCE INSTRUCTIONS

Federal Regulations require Coast Guard approved PFDs that are legibly marked with the Coast Guard approval number, are in good and serviceable condition, and are the correct size for each person on board. It is the responsibility of the operator to be sure this PFD is in serviceable condition. To be considered serviceable, this PFD shall not exhibit deterioration that could diminish its performance, such as broken or deformed hardware, detached webbing, rotted structural components, air leaks or nonfunctional inflators. Unless worn inflated, this PFD must also be properly armed with a cylinder installed in the inflator, a yellow bobbin (water sensing element) installed for MD2016, and service indicator showing green. See Component Inspection Instructions. Failure to follow these instructions rigorously could result in a non-functioning PFD causing injury or death.

Check the following at the intervals listed below.

### 1) Before Each Use:

- i) Examine the service indicator through the window panel, ensuring it is green. If the indicator is red, the mechanism requires service. See Re-arming Your PFD (MD2014) on page 8 or see Re-arming Your PFD (MD2016) on page 10.
- ii) Ensure the manual pull-tab is accessible.
- iii) Visually examine your Inflatable PFD for damage or excessive abrasion, wear, tear or contamination. Particular attention must be paid to the stitching, straps and hardware. If in doubt, send it to your Mustang dealer for evaluation and/or servicing.

### 2) Every Two (2) Months:

- i) Leak Test: The Inflatable PFD should be tested for general leakage by orally inflating your Inflatable PFD until firm and let stand for 16 hours. A leaking Inflatable PFD will not hold its firmness and should be replaced. If your Inflatable PFD leaks, take it to your Mustang dealer for evaluation and/or servicing. Repack the Inflatable PFD as outlined in the Repacking section on page 13.
- ii) Oral Inflation Valve Test: To check the oral inflation valve, fully inflate the Inflatable PFD using the oral inflator and hold valve under water. If bubbles appear, deflate and re-inflate to test again. Should the leak persist, take your

Inflatable PFD to your Mustang dealer for evaluation and/or servicing.

---

**CAUTION: To avoid accidental inflation, don't allow the water to contact the inflator (MD2016).**

---

- iii) Perform a thorough visual examination. See **Readiness Checklist** on page 3.  
Perform these tests more often if exposed to potential damage or used in extreme conditions.
- 3) **After Each Inflation** - Re-arm the Inflatable PFD. See Re-arming Your PFD (MD2014) on page 8 or Re-arming Your PFD (MD2016) on page 10.
- 4) **Annually** - Perform the following at the beginning of each boating season, after inflation, or whenever the integrity of the Inflatable PFD is in doubt:
  - i) Check all components for dirt or corrosion. Clean or replace, as necessary. See **Readiness Checklist** on page 3.
  - ii) Visually examine your Inflatable PFD for damage or excessive abrasion, wear, tear or contamination. Particular attention must be paid to the stitching, straps and hardware. If in doubt, send it to your Mustang dealer for evaluation and/or servicing.
  - iii) Perform the Oral Inflation Valve Test: See the Oral Inflation Valve Test in the Every Two (2) Months Care and Maintenance Instructions section.
  - iv) Perform the Leak Test. See the Leak Test in the Every Two (2) Months Care and Maintenance Instructions section.
  - v) **For MD2016 only.** Ensure the current date is not three (3) years past the date on the bobbin. If it is, re-arm the inflator (see Re-arming Your PFD (MD2016) on page 10).
  - vi) Ensure the service indicator is green (Fig. 1).
  - vii) Record as an "Annual" inspection in permanent ink on the Care and Storage label, in the Date Maintained column.

Repack the Inflatable PFD as outlined in the Repacking section on page 13.

---

**WARNING: If you are not confident in the self-inspection and servicing of your Inflatable PFD in**

accordance with these instructions, take your Inflatable PFD to a Mustang dealer for professional servicing or contact Mustang Survival (see contact information on back of manual).

---

## **CLEANING AND STORING OF YOUR INFLATABLE PFD (MD2014)**

To clean your Inflatable PFD, remove the CO<sub>2</sub> cylinder/bayonet assembly. Hand wash or sponge down the Inflatable PFD, including inflator, in warm, soapy water and rinse with clean water. Hang to dry on a plastic coat hanger. Be sure to replace CO<sub>2</sub> cylinder/bayonet assembly (see "Re-arming Your PFD (MD2014)" on page 8).

Always store your Inflatable PFD in a warm, dry place out of direct sunlight.

## **CLEANING AND STORING OF YOUR INFLATABLE PFD (MD2016)**

To clean your Inflatable PFD, remove the CO<sub>2</sub> cylinder/bayonet assembly, cap and bobbin. Keep the bobbin dry. Hand wash or sponge down the Inflatable PFD in warm, soapy water. Rinse the PFD and inflator with clean water. Hang the Inflatable PFD to dry on a plastic coat hanger. Ensure the inflator is thoroughly dry before installing the bobbin. Be sure to replace CO<sub>2</sub> cylinder/bayonet assembly, cap and bobbin (see "Re-arming Your PFD (MD2016)" on page 10).

Always store your Inflatable PFD in a warm, dry place out of direct sunlight.

## **HOW AND WHY TO TEST YOUR PFD**

Inflate your Inflatable PFD and try it out in the water to:

Make sure it floats you:

- Comfortably (when worn properly)
- Adequately for expected wave conditions (body shapes/densities affect performance)

Make sure it works:

- A flow of bubbles should not appear (see "Care and Maintenance Instructions" on page 14 for leak tests). It should inflate quickly

and easily.

Learn how it works by:

- Activating the CO<sub>2</sub> inflation system
- Re-arming the CO<sub>2</sub> inflation system
- Using the oral inflator tube

To check the manual inflation system (with CO<sub>2</sub> cylinder/bayonet assembly removed); determine that the CO<sub>2</sub> cylinder piercing pin moves freely when pushing up on the lever arm by pushing down on the pins and releasing the pins followed by the lever arm (for MD2014 see Fig. 8 and for MD2016 see Fig. 11). Repeat this several times to check the manual inflation system.

## **MODEL MD2016**

The U.S.Coast Guard recommends that you purchase two re-arming kits (MA2014). One kit is to be used immediately in testing the automatic inflation system (see HOW DO YOU TEST YOUR PFD USING THE AUTOMATIC INFLATOR?) and the other to carry on board as a spare.

The U.S. Coast Guard recommends you test the automatic inflation system in the water at the beginning of each boating season. By doing this, you demonstrate that the automatic inflation system is still working properly and reduce the likelihood of premature inflation and its associated dangers.

## **HOW DO YOU TEST YOUR PFD USING THE AUTOMATIC INFLATOR? (MD2016)**

- 1) To test your Inflatable PFD, you will need your fully armed Inflatable PFD, and re-arming kit (MA2014) approved for your Inflatable PFD
- 2) Put on the Inflatable PFD.
- 3) Get into shallow water, just deep enough that you can stand with your head above the surface. Once the inflator is underwater the Inflatable PFD should fully inflate automatically within 10 seconds.
- 4) See if the Inflatable PFD will float you on your back or just slightly back of vertical. In a relaxed floating position, verify that your mouth is well above the water's surface. Note the effect of where you hold your legs on how you float.

- 5) Get out of the water and remove the Inflatable PFD. Remove the used CO<sub>2</sub> cylinder/bayonet assembly and the used bobbin from the Inflatable PFD inflator.

Completely deflate the PFD using the oral inflator. See Deflating the Inflatable PFD on page 7.

- 6) Let the Inflatable PFD dry thoroughly. Re-arm and Repack the PFD (see "Re-arming Your PFD (MD2016)" on page 10 and see "Repacking" on page 13).

## **HOW DO YOU TEST YOUR PFD USING THE MANUAL INFLATOR?**

- 1) To test your Inflatable PFD, you will need your fully armed Inflatable PFD, and re-arming kit approved for your Inflatable PFD: MA2014.
- 2) Put on the Inflatable PFD.
- 3) Actuate the inflation system by jerking firmly downward on the pull-tab. The Inflatable PFD should fully inflate within 5 seconds.
- 4) Get into shallow water, just deep enough that you can stand with your head above the surface.
- 5) See if the Inflatable PFD will float you on your back or just slightly back of vertical. In a relaxed floating position, verify that your mouth is well above the water's surface. Note the effect of where you hold your legs and how you float.
- 6) Get out of the water and remove the Inflatable PFD. Completely deflate the Inflatable PFD using the oral inflator (see Deflating the Inflatable PFD on page 7). Remove the CO<sub>2</sub> cylinder/bayonet assembly from the inflator.
- 7) Let the Inflatable PFD dry thoroughly. Re-arm and Repack the PFD (see "Re-arming Your PFD (MD2014)" on page 8 or see "Re-arming Your PFD (MD2016)" on page 10 and see "Repacking" on page 13).

## HOW DO YOU TEST YOUR PFD USING THE ORAL INFLATOR?

- 1) No spare parts or re-arming kits are needed to test your Inflatable PFD.
- 2) Remove the CO<sub>2</sub> cylinder/bayonet assembly to prevent inadvertent inflation, which could potentially damage the Inflatable PFD. Inspect the cylinder to confirm it is unused (Fig. 10). Unscrew and remove the cap and the bobbin (MD2016 only). Otherwise the bobbin will disintegrate during water immersion.
- 3) Put on the Inflatable PFD.
- 4) Get into shallow water, just deep enough that you can stand with your head above the surface.
- 5) If you are a weak swimmer or non-swimmer, orally inflate the Inflatable PFD partially so that you are supported well enough to be able to complete inflation without touching bottom. Note this level of inflation because it is the minimum needed for you to safely use this Inflatable PFD.
- 6) Fully inflate the Inflatable PFD using the oral inflator.
- 7) See if the Inflatable PFD will float you on your back or just slightly back of vertical. In a relaxed floating position, verify that your mouth is well above the water's surface. Note the effect of where you hold your legs on how you float.
- 8) Get out of the water and remove the Inflatable PFD. Completely deflate the Inflatable PFD using the oral inflator.
- 9) Let the Inflatable PFD dry thoroughly. Re-arm (for your model) and Repack the PFD (see "Re-arming Your PFD (MD2014)" on page 8 or see "Re-arming Your PFD (MD2016)" on page 10 and see "Repacking" on page 13).

## WEAR YOUR PFD

In approximately 80 percent of all boating fatalities, the victims were not wearing a PFD. Most fatal accidents happen on calm sunny days. This Inflatable PFD is much more comfortable to wear than other PFD types. Get into the habit of wearing this Inflatable PFD.

Non-swimmers and children especially should wear a hybrid or non-Inflatable PFD at all times when on or near the water.

# HYPOTHERMIA

Prolonged exposure to cold water causes a condition known as hypothermia - a substantial loss of body heat, which leads to exhaustion and unconsciousness. Most drowning victims first suffer from hypothermia. The following chart shows the effects of hypothermia: how hypothermia affects most adults.

## How hypothermia affects most adults

Water Temperature °C (°F)	Exhaustion or Unconsciousness	Expected Time of Survival
0.3 (32.5)	Under 15 min.	Under 15–45 min.
0.3–4 (32.5–40)	15–30 min.	30–90 min.
4–10 (40–50)	30–60 min.	1–3 hrs
10–16 (50–60)	1–2 hrs.	1–6 hrs.
16–21 (60–70)	2–7 hrs.	2–40 hrs.
21–27 (70–80)	2–12 hrs.	3 hrs. to Indefinite
over 27 (over 80)	Indefinite	Indefinite

PFDs can increase survival time because they allow you to float without using energy treading water and because of their insulating properties. Naturally, the warmer the water, the less insulation you will require. When operating in cold waters [below 60°F (15.6°C)] you should consider using a coat or jacket style PFD or a Type V Thermal Protective PFD as they cover more of the body than the vest or belt style PFDs. Some Points to Remember About Hypothermia Protection:

- 1) Always wear your Inflatable PFD. Even if you become incapacitated due to hypothermia, the Inflatable PFD will keep you afloat and greatly improve your chances of rescue.

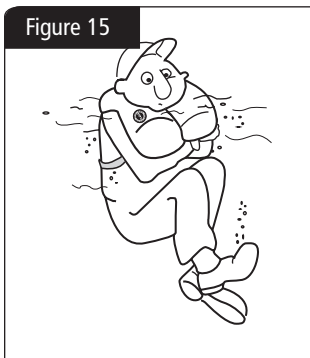

Figure 15

- 2) Do not attempt to swim unless it is to reach a nearby craft, fellow survivor, or a floating object on which you can lean or climb. Swimming increases the rate of body heat loss. In cold water, drown-proofing methods that require putting your head in the water are not recommended. Keep your head out of the water. This will greatly lessen heat loss and increase your survival time.

- 3) Use the standard H.E.L.P. position when wearing an Inflatable PFD, drawing the legs up to a seated position, because doing so will help you conserve body heat (Fig. 15).
- 4) Keep a positive attitude about your survival and rescue. This will improve your chances of extending your survival time until rescued. Your will-to-live does make a difference!
- 5) If there is more than one person in the water, huddling is recommended while waiting to be rescued. This action tends to reduce the rate of heat loss and thus increase the survival time.

## **EACH OF THESE DEVICES IS INTENDED TO HELP YOU SAVE YOUR OWN LIFE**

For your Inflatable PFD to function properly, follow these suggestions to verify that it fits, floats, and remains in good condition.

- 1) Check the inflation mechanism status indicators before each use.
- 2) Get in the habit of re-arming the inflation mechanism right after each inflation.
- 3) Try your wearable Inflatable PFD on and adjust it until it fits comfortably in and out of the water.
- 4) Mark your Inflatable PFD with your name if you are the only wearer.
- 5) Do not alter your Inflatable PFD. If it doesn't fit properly, get one that does. An altered device is no longer Coast Guard approved.
- 6) Your Inflatable PFD is not intended for use as a fender or kneeling pad.
- 7) If your Inflatable PFD is wet, allow it to dry thoroughly before storing it. Store it in a well-ventilated area.
- 8) Do not dry your Inflatable PFD in front of a radiator or other source of direct heat.

## **INFLATABLE PFD SAFETY ACCESSORIES**

MA2014 Re-arm Kit – Contains 24-gram replacement CO<sub>2</sub> cylinder/bayonet assembly and bobbin. MD2014 will not use the bobbin.



## **ADDITIONAL INFORMATION**

If you need more information about PFDs and safe recreational boating, contact your state boating authority, U.S. Coast Guard Auxiliary, U.S. Power Squadron, Red Cross, or your nearest unit of the U.S. Coast Guard; or call the free boating course number 1-800-336-BOAT (in VA, 1-800-245-BOAT).

## **DO NOT ATTACH PFD'S TO YOUR BOAT**

Each PFD has straps, hooks, buckles, or other means for securing the device in place on the wearer. Some PFDs also incorporate decorative d-rings or tabs. Such items are not to be used to attach the device to the boat. Attaching the device to the boat will not permit it to perform as intended.

## **AIRLINE OPERATOR POLICY ON CARRIAGE OF INFLATABLE PFDs AND CO<sub>2</sub> CARTRIDGES**

Please be aware that the following regulations apply to the air transport of this product. According to U.S. Research and Special Programs Administration Regulations Title 49 CFR 75.10(a)(25): With the approval of the aircraft operator, one small carbon dioxide cylinder fitted into a self-inflating jacket, plus one spare cartridge, may be carried by a passenger or crew in checked or carry-on baggage.

Please refer to the governing body's documentation, found online at <http://hazmat.dot.gov>.





Mustang Survival has been providing lifesaving solutions for over 45 years. Through constant innovation and the application of new technologies, Mustang is the leading supplier of quality flotation and hypothermia protection products to the most demanding users — from fishermen, sailors and commercial mariners to the Coast Guard, fighter pilots and even NASA astronauts.



**WE SAVE LIVES FOR A LIVING**  
**[mustangsurvival.com](http://mustangsurvival.com)**

TOLL FREE 1.800.526.0532 | EMAIL [CUSTSERV@MUSTANGSURVIVAL.COM](mailto:CUSTSERV@MUSTANGSURVIVAL.COM)

Mustang Survival and seahorse design is a registered trademark of Mustang Survival Corp.

Our commitment to quality has earned our Burnaby facilities ISO 9001 registration, the highest of all international standards. This is our guarantee you're receiving the ultimate in design and manufacturing.